

Data Sheet



Article number: 20611523

Description: E+G indexing mechanism
GN 200-44-K10-B

Measures

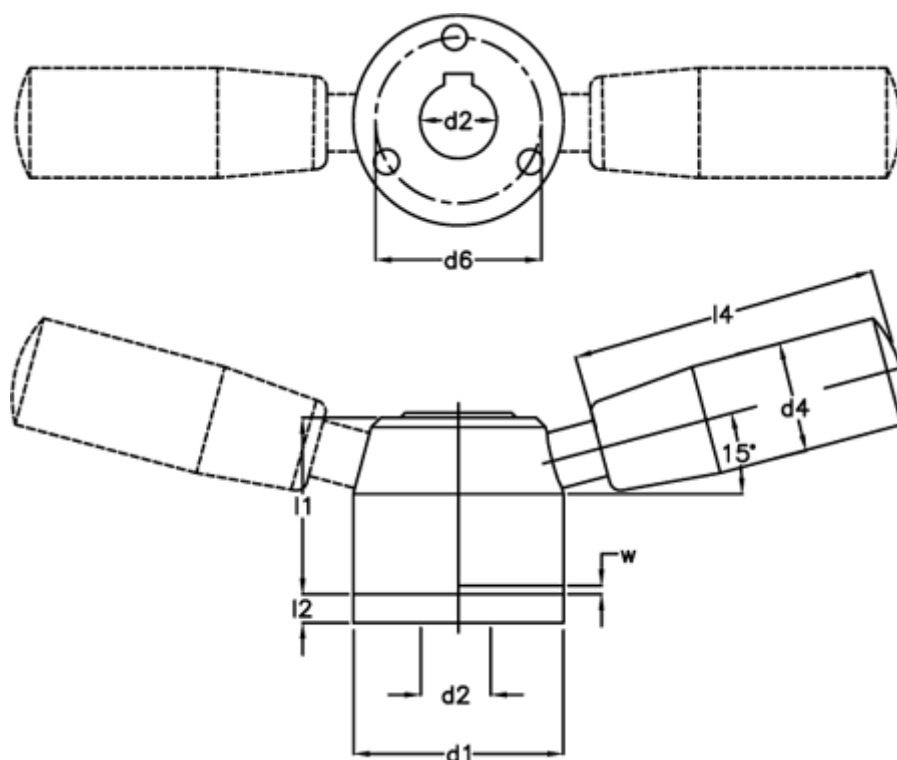

$d_1 = 44$	$l_4 = 75$
$d_2 = K10$	$W = 4$
$d_4 = 23$	
$d_5 = 23.0$	
$d_6 = 33.0$	
$l_1 = 37.0$	
$l_2 = 6$	
$l_3 = 31.0$	